







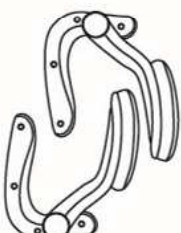
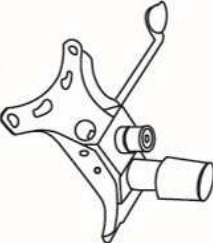

MODEL: B8551

<p>(1)x1</p>  <p>Back Cushion</p> <p>(4)x1</p>	<p>(2)x1</p>  <p>Seat Cushion</p> <p>(5)x1</p>	<p>(3)x1 (L)x1 (R)</p>  <p>Left-Arm-L, Right-Arm-R</p> <p>(6)x1</p>
<p>Mechanism</p>  <p>(7)x5</p>	<p>Gas Lift W/ Cover</p> 	<p>Base</p> 
<p>Caster</p> 		

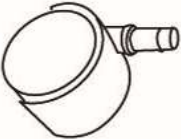
- (A)\*4  M8\*22 MECHANISM SCREW
- (B)\*8  M6\*25 ARM SCREW
- (C)\*8  ARM CAP

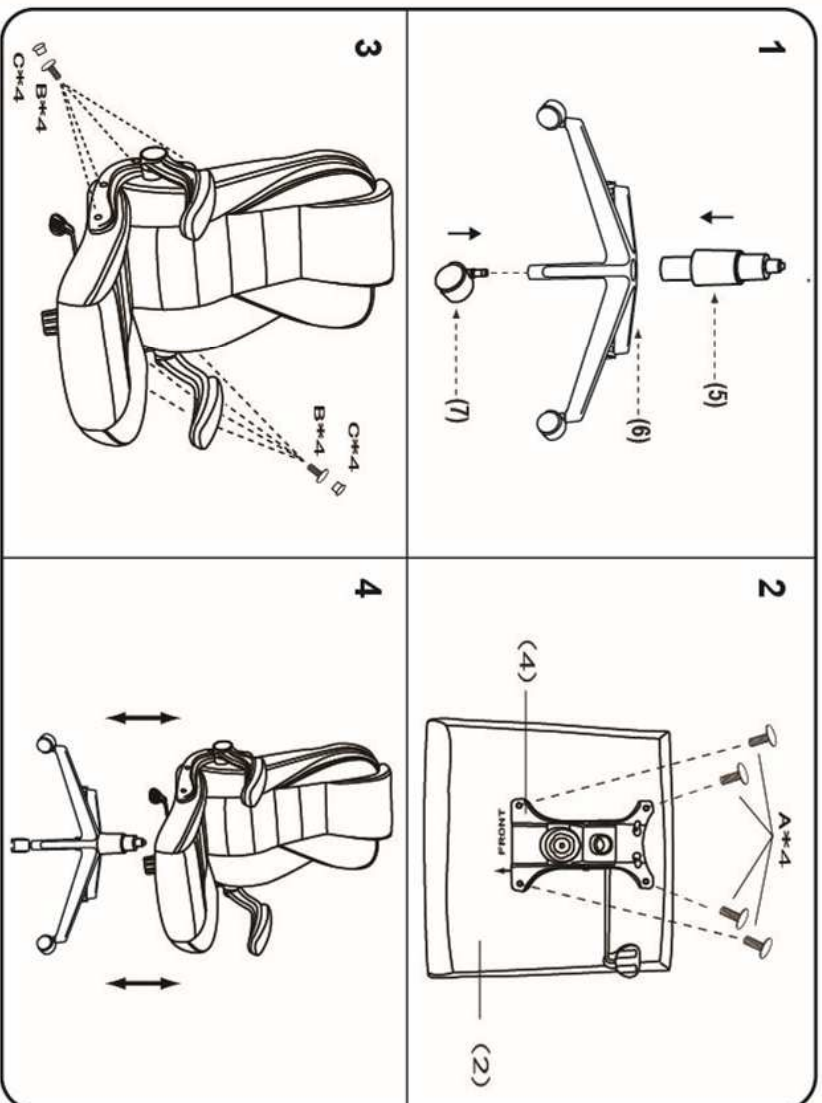

**Insert and loosely tighten all screws. When assembly is completed, fully tighten all screws before using. This chair is only intended for sitting. Any other use will void the warranty.**

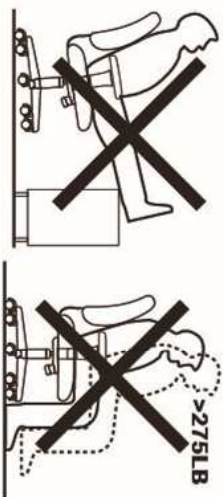

>275LB

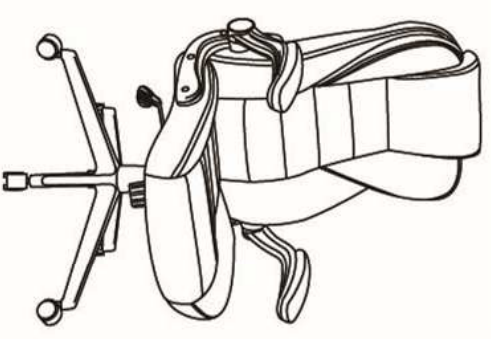

Customer Service Hotline: 1-800-593-1888 For further assembly instructions, please visit our website at [www.bosschair.com](http://www.bosschair.com)

08/20