

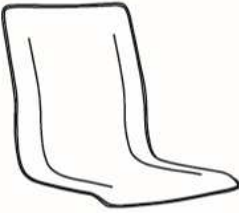

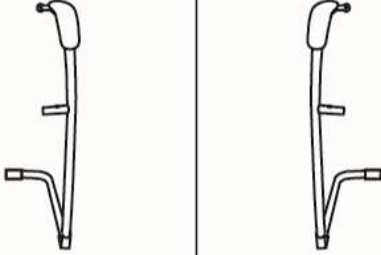





**IMPORTANT NOTICE:  
HARDWARE PACKAGE IS ATTACHED  
ON THE BOTTOM OF SEAT CUSHION.**

MODEL: B9530 B9535 YS12 YS112

(1)x1 	(2)x1  Arm-Left	(3)x1  Arm-Right
(4)x1 	(5)x1 	
<p>(A)X2  M6 X 12 SCREWS FOR BOTTOM TUBE</p> <p>(B)X2  LONG BLACK SCREWS FOR TOP TUBE AND SEAT</p> <p>(C)X2  SHORT SILVER SCREWS FOR BACKREST</p> <p>(D)X1  ALLEN KEY</p>		

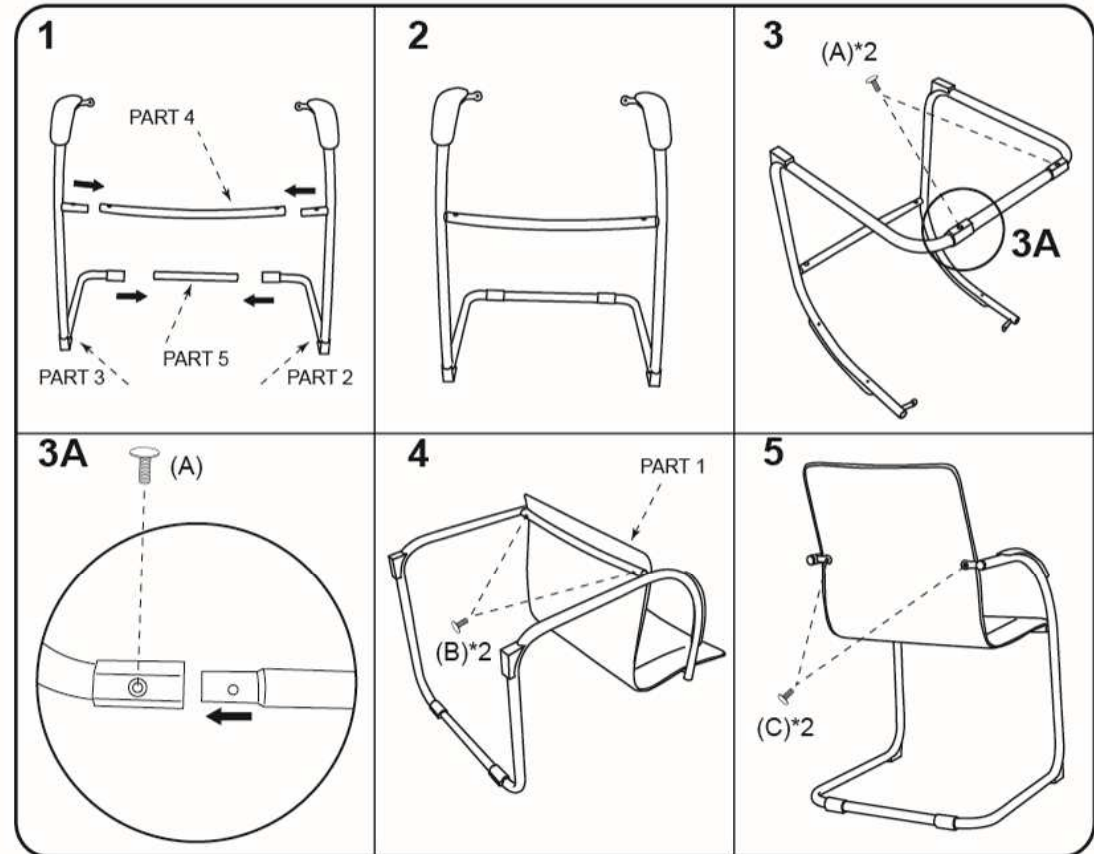

**Insert and loosely tighten all screws. When assembly is completed, fully tighten all screws before using. This chair is only intended for sitting. Any other use will void the warranty.**

