







Assembly Instructions MODEL NO. N6002

KD

A		B		C		D		E		F		G	
	Cam lock 2Pcs+1Pc		Kitx Cam 2Pcs+1Pc		Cam Cover 2Pcs+1Pc		Dowel 3Pcs+1Pc		Adjustable Glide 2Pcs		Grommet 2Pcs		4-Hole Plate 6Set

STEP1

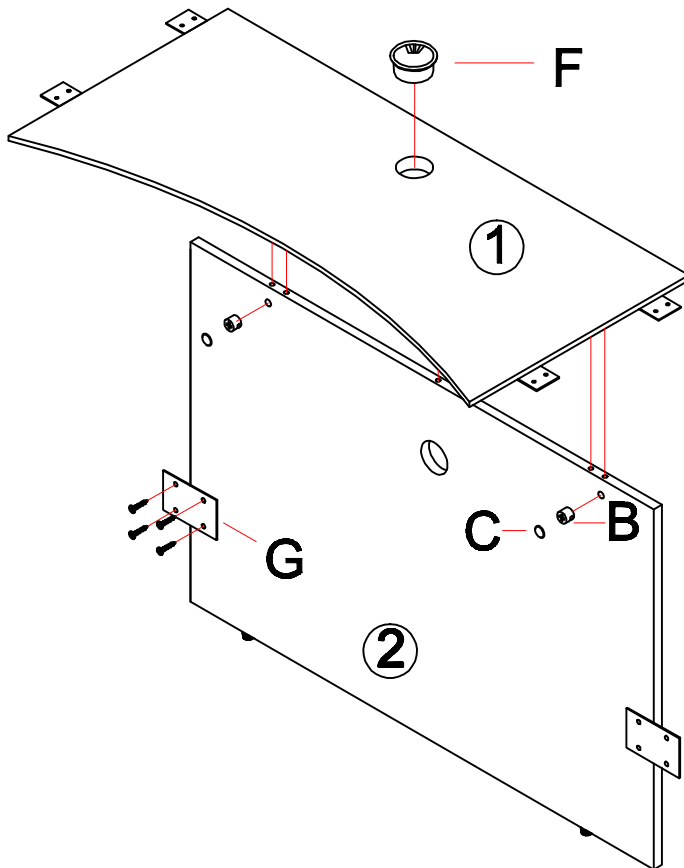

IMPORTANT NOTE:

- Place all laminated parts on a clean and smooth surface such as a rug or carpet to avoid the parts from being scratched.
- Check to be sure that you have all parts and hardware.
- Remove all wrapping materials, including staples & packing straps before you start to assemble.
- Don't tighten all screws/bolts until all completely assembled.
- Keep all hardware parts out of reach of children