





Assembly Instructions

MODEL NO. : NTT4XLBS

BLACK METAL POST LEG WITH CASTER

A	TUN018SC	C	E
 Caster 4Pcs	 Screw #4x1/2" 16Pcs	 1Pcs	 Screw #4x4" 4Pcs

STEP1

STEP2

STEP3

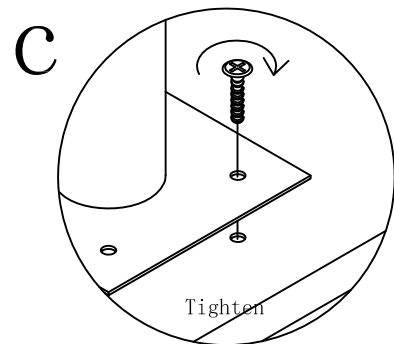
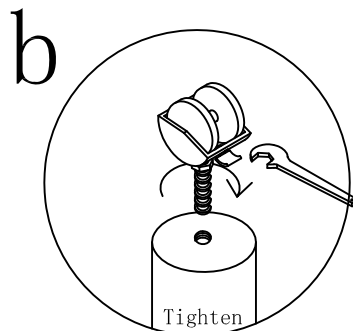
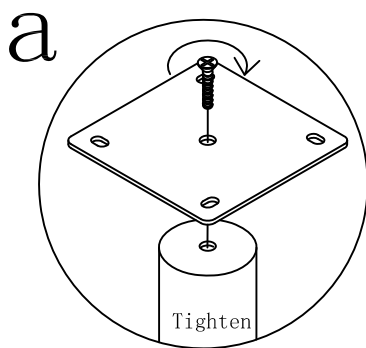
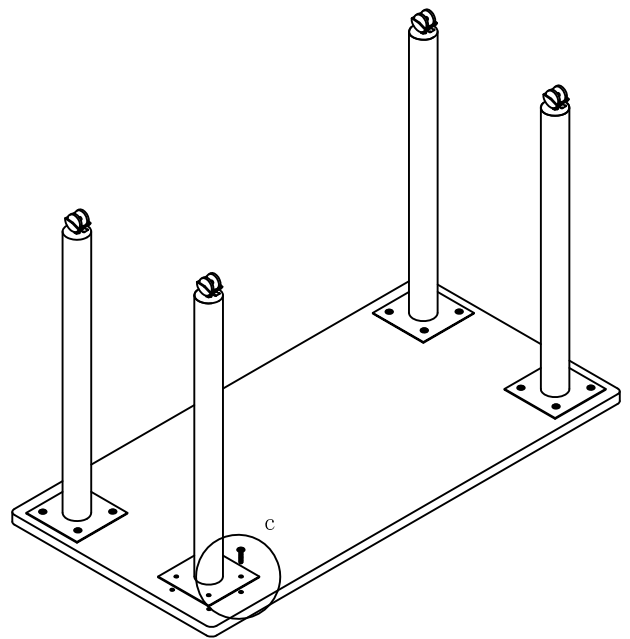
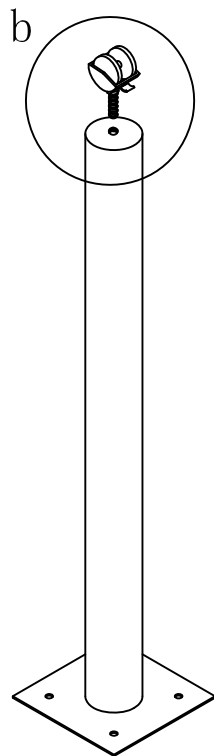
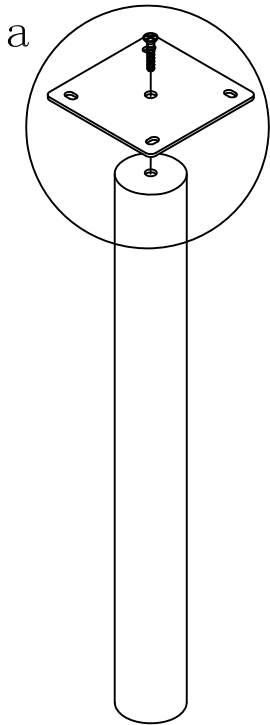

IMPORTANT NOTE:

- Place all laminated parts on a clean and smooth surface such as a rug or carpet to avoid the parts from being scratched.
- Check to be sure that you have all parts and hardware.
- Remove all wrapping materials, including staples & packing straps before you start to assemble.
- Don't tighten all screws/bolts until all completely assembled.
- Keep all hardware parts out of reach of children