















# Assembly Instructions

## MODEL NO.N269G

### GLAZED RECEPTION DESK

TUN010CL	TUN011KC	C	TUN026	TUN021AG	TUN013LB	TUN018SC	TUN015BG	I	J	K	L	M	N
													
Cam lock 14Pcs+1Pc(spare)	Klix Cam 14Pcs+1Pc(spare)	Cam Cover 14Pcs+1Pc(spare)	Dowel 9Pcs+1Pc(spare)	Adjustable Glide 4Pcs	6Hole L-Bracket 5Pcs	Screw#4*5/8" 48Pcs+1Pc(spare)	60mm Black Grommet 2Pcs	Cover 4Pcs+1Pc(Spare)	Screw#10*40 4Pcs	2Set	2Set	1Pcs	2Set

#### STEP1

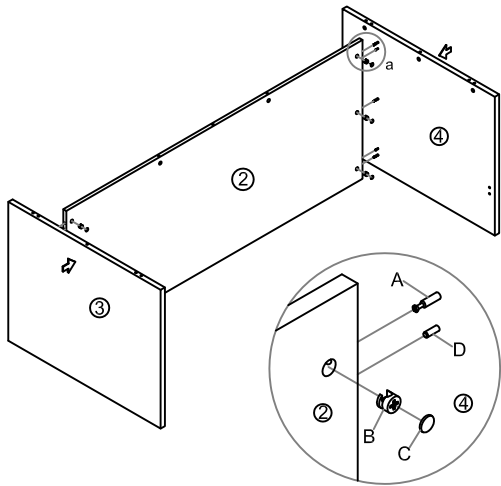

**IMPORTANT:  
FUNCTION OF KLIX CAM**



1/4 RIGHT  
TURN FOR  
LOCKING  
Make Sure The Arrow Is  
Pointing Upwards Before  
Inserting Into The Panel's Hole

#### STEP2

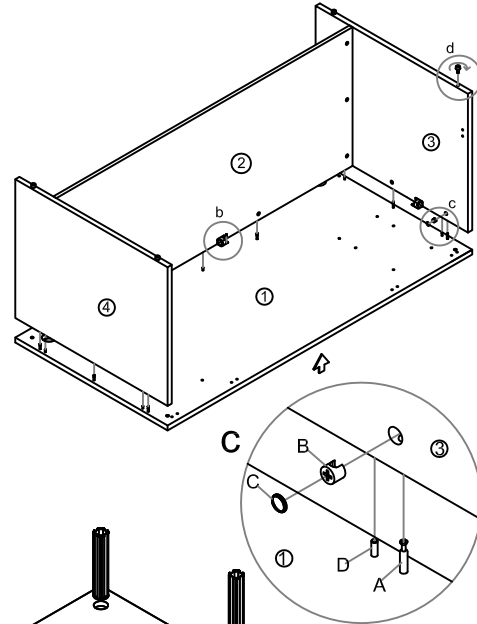

#### STEP3

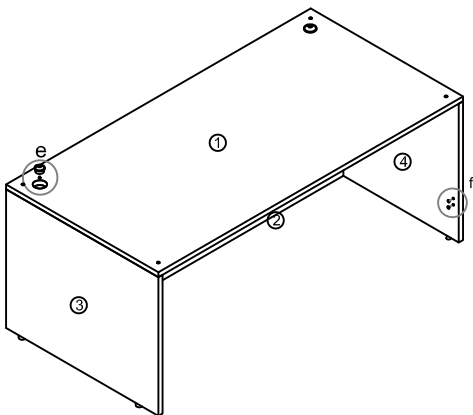

#### STEP4

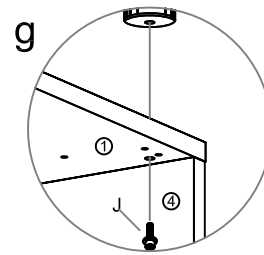
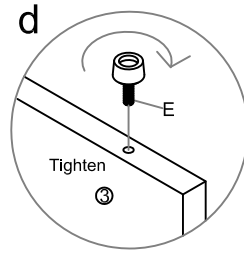
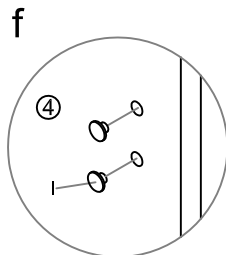
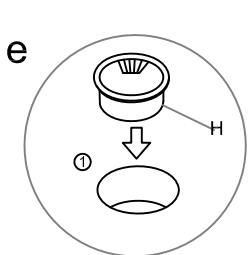
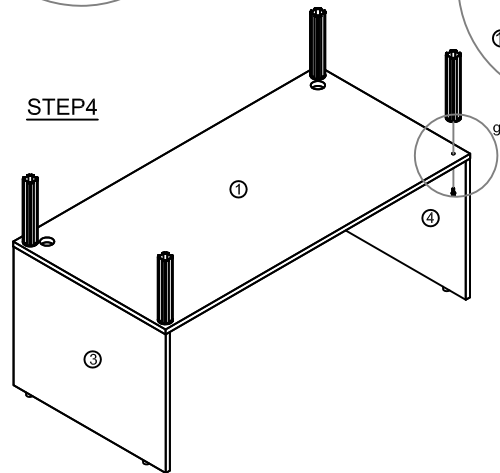















#### IMPORTANT NOTE:

- Place all laminated parts on a clean and smooth surface such as a rug or carpet to avoid the parts from being scratched.
- Check to be sure that you have all parts and hardware.
- Remove all wrapping materials, including staples & packing straps before you start to assemble.
- Don't tighten all screws/bolts until all completely assembled.
- Keep all hardware parts out of reach of children

# Assembly Instructions

## MODEL NO.N269G

### GLAZED RECEPTION DESK

TUN010CL	TUN011KC	C	TUN026	TUN021AG	TUN013LB	TUN018SC	TUN015BG	I	J	K	L	M	N
													
Cam lock 14Pcs+1Pc(spare)	Klik Cam 14Pcs+1Pc(spare)	Cam Cover 14Pcs+1Pc(spare)	Dowel 9Pcs+1Pc(spare)	Adjustable Glide 4Pcs	6Hole L-Bracket 5Pcs	Screw#4*5/8" 46Pcs+1Pc(spare)	60mm Black Grommet 2Pcs	Cover 4Pcs+1Pc(Spare)	Screw#10*40 4Pcs	2Set	2Set	1Pcs	2Set

#### STEP5

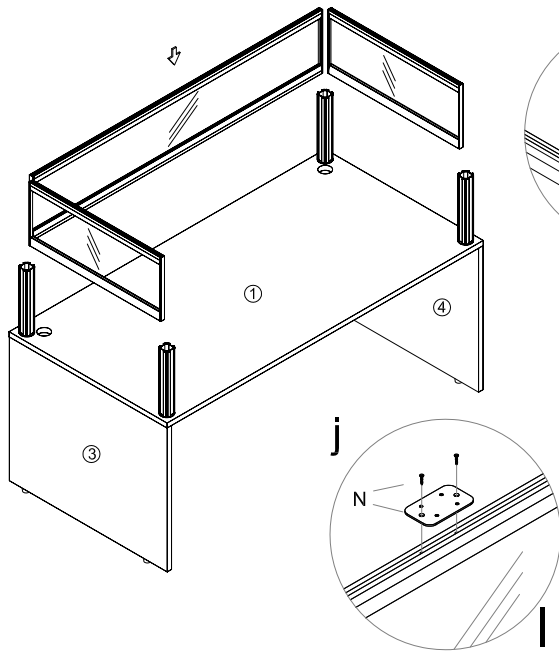

#### STEP6

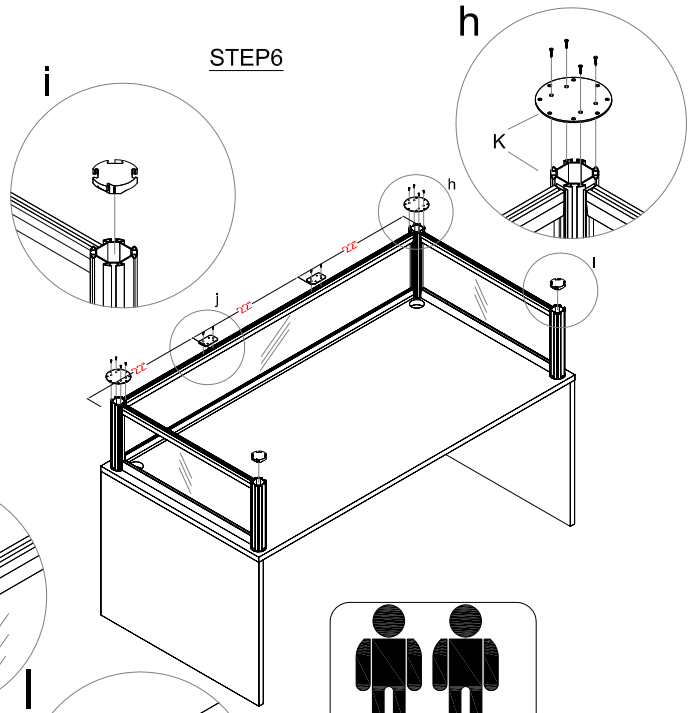

#### STEP7

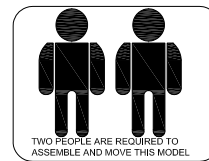
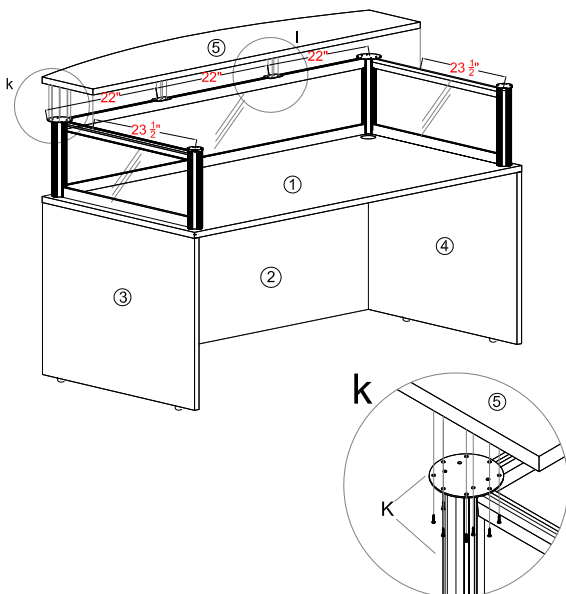

COMPLETED ASSEMBLY

#### IMPORTANT NOTE:

- Place all laminated parts on a clean and smooth surface such as a rug or carpet to avoid the parts from being scratched.
- Check to be sure that you have all parts and hardware.
- Remove all wrapping materials, including staples & packing straps before you start to assemble.
- Don't tighten all screws/bolts until all completely assembled.
- Keep all hardware parts out of reach of children